

PACK
IT YOUR
WAY

UNIQUE
HORIZONTAL
FLOW
WRAPPER

Laferpack

www.laferpack.com

PACK IT YOUR WAY





Laferpack

Simply passion for our job, desire to share our knowledge, pride of meeting our customers' expectations: for this reason, when we talk about packaging machines, we give priority to the human being.

We exactly know that the value of each machine is rated by the ability of doing properly what it has been built for.

Every customer becomes a partner who imagines the possibilities and who looks for the solution to which we give shape and substance.

Any idea is evaluated to be the most rational as possible; it is designed, tested and applied. Every project becomes an opportunity to further improve what we do. We offer customized solutions aimed to satisfy the needs of that person that will employ it; machines with reduced maintenance time and operating costs, machines easy and intuitive to be programmed.

This is our thought, that is realized with the help of all means that modern technology offers to reduce energy consumption, but without losing sight of the needs of those who will daily use the machines we build.

Semplicity is the ultimate sophistication

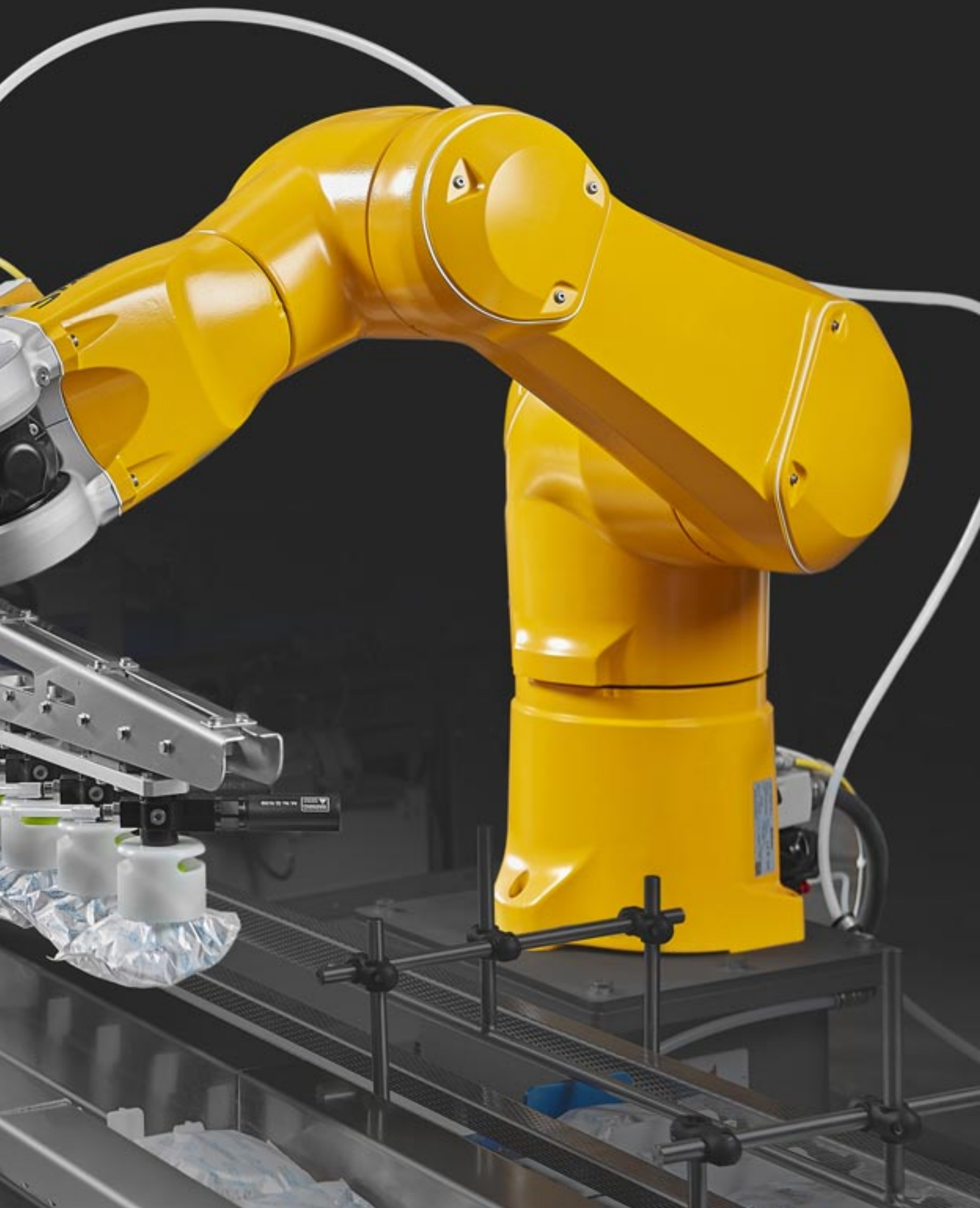

PLANET A

THE NEW FRONTIER
OF THE ESSENTIAL

Full servo top reel flow wrapper with three Brushless motors especially designed for manual loading, with the same strengths of the high-level Laferpack machines: cantilever structure; 7" user-friendly colour touch-screen; complete access to the operation area.

PLANET B

INVERTED SIMPLICITY

Full servo bottom reel flow wrapper with three Brushless motors especially designed for manual loading, with the same strengths of the high-level Laferpack machines: cantilever structure; 7" user-friendly colour touch-screen; complete access to the operation area.

Technical Specifications		PLANET A	PLANET B
Maximum product width	mm	180	180
Maximum product height	mm	100	100
Bag length (min/max)	mm	80 / 530	80 / 530
Maximum reel width	mm	500	500
Max Speed	p.p.m.	60 / 120	60 / 120
Wrapping materials		heat & cold sealable materials	





PLANET A



PLANET B



COSMIC



WIDE B

COSMIC

STRENGTH AND FLEXIBILITY
OF USE REMOVING THE ENTRY
LEVEL CONCEPT

Full servo suitable for manual loading or integrated with low/medium speed automatic lines.

The same strengths of the top-range machines are applied on COSMIC: balcony frame execution, friendly use HMI graphic software, complete access to the operation area of the machine protected by a robust safety cover and a wide range of options.

Technical Specifications		COSMIC
Maximum product width	mm	250
Maximum product height	mm	120
Bag length (min/max)	mm	50 / 600
Maximum reel width	mm	650
Max Speed	p.p.m.	150
Wrapping materials	heat & cold sealable materials	

WIDE B

THE ALTERNATIVE FOR
DIFFICULT PRODUCTS

Full servo suitable for manual loading or to be linked in low/medium speed automatic lines.

The bottom film feed (reverse flow pack) allows the packaging of products difficult to be handled with different solutions.

Ideal application for food (loose vegetables, fish...), and non-food (plastic and hardware items, clothes...).

Technical Specifications		WIDE B
Maximum product width	mm	250
Maximum product height	mm	120
Bag length (min/max)	mm	50 / 600
Maximum reel width	mm	650
Max Speed	p.p.m.	150
Wrapping materials	heat & cold sealable materials or polyethylene	



MOTION A

DEAL WITH SIMPLICITY
IN COMPLICATED APPLICATIONS

The box motion cross sealing head allows to obtain hermetic seals for gas flushing packaging (MAP). The perfect solution when an aesthetically pleasing design and high quality gussets are required and in cases of packaging with thick wrapping materials. Bottom reel version available.

MOTION B

HIGH PERFORMANCES,
FLEXIBILITY AND HERMETIC SEALING
IN A SINGLE SOLUTION

Bags with hermetic seals containing products that are difficult to handle are obtained by using a “box-motion” sealing head combined with bottom film feeding.





MOTION A



MOTION B

Technical Specifications		MOTION A	MOTION B
Maximum product width	mm	320	320
Maximum product height	mm	120	120
Bag length (min/max)	mm	80 / 600	80 / 600
Maximum reel width	mm	750	750
Max Speed	p.p.m.	80	80
Wrapping materials	heat & cold sealable materials or polyethylene		heat & cold sealable materials or polyethylene

RENEWABLE **recycl**
eco-friendly
biodegradable **NATURAL** **planet**



S U S T A I N

ing
GREEN

ECOLOGY

FUTURE

GREEN

environmental

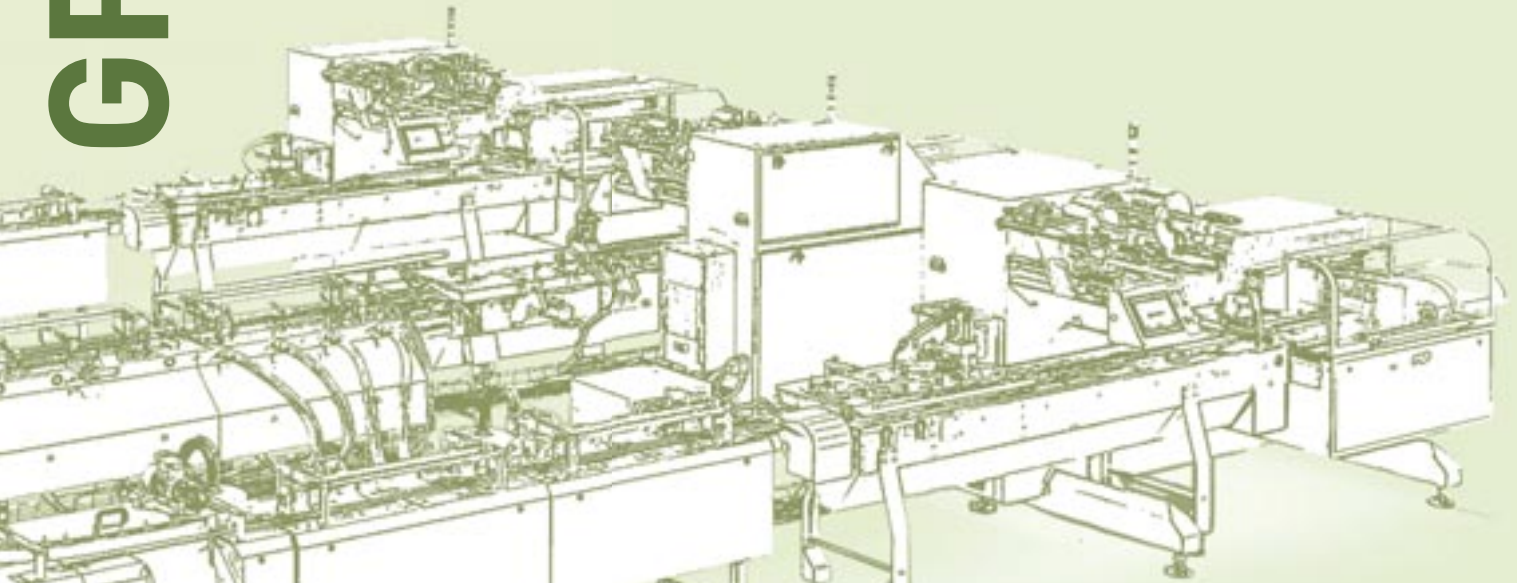

A B I L I T Y



FAST

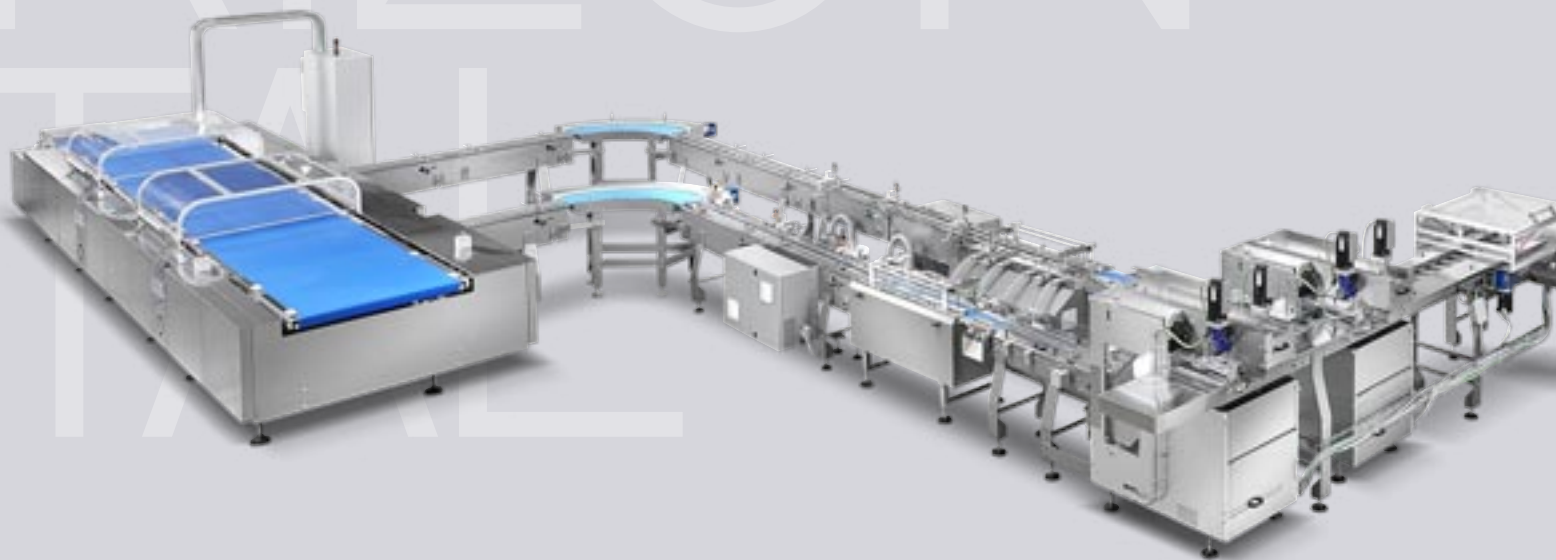

Rationality and synthesis of technology for high-performance applications

Designed and built for continuous use in automatic lines. Fully electronic machine developed for high performance platform. Equipped with double pneumatic reel holder shaft, automatic reel splicer, longitudinal seal assembly with preheating device, cross sealing head with double jaw, friendly use HMI graphic software with provision for printer and up-stream/down-stream control interface.



Technical Specifications		FAST
Maximum product width	mm	120
Maximum product height	mm	60
Bag length (min/max)	mm	80 / 250
Maximum reel width	mm	400
Max Speed	p.p.m.	600
Wrapping materials	heat & cold sealable materials	

DISKO

COMPACT AND FULLY
AUTOMATIC

Fully electronic 4 axis high speed machine specifically designed for packaging of candies and hard confectionery in Flowpack style.

The basic version provides single packing of products and can be equipped with proper optional devices to obtain:

DISKO L

WHEN EFFICIENCY
JOINS QUALITY

bags in chain with pre-cutting, multipack, packing of cicklets, packing of lollipops, inclusion of gift (plastic eggs, stickers, cards).

Technical Specifications		DISKO	DISKO L
Maximum product width	mm	40	35
Maximum product height	mm	30	35
Bag length (min/max)	mm	47 / 75	90 / 180
Maximum reel width	mm	150	250
Max Speed	p.p.m.	1.500	550
Wrapping materials		heat & cold sealable materials	





DISKO



DISKO L



4S



4S _ Single reel



4S _ Double reel

**4-side seal profile,
Robust in nature,
A different concept
of packaging.**

4S

A fully electronic high-speed machine able to make a four-sided seal bag from one or two film reels completely sealed on all four sides with no gussets. The sealing of all sides provides a uniform bag style and enhanced product protection from leakage.

Front and back sides are totally free to increase the brand messaging or to see the products better. The absence of the longitudinal flap and the reduced profiles of the seals reduce the space occupied by a single bag on the carton box.



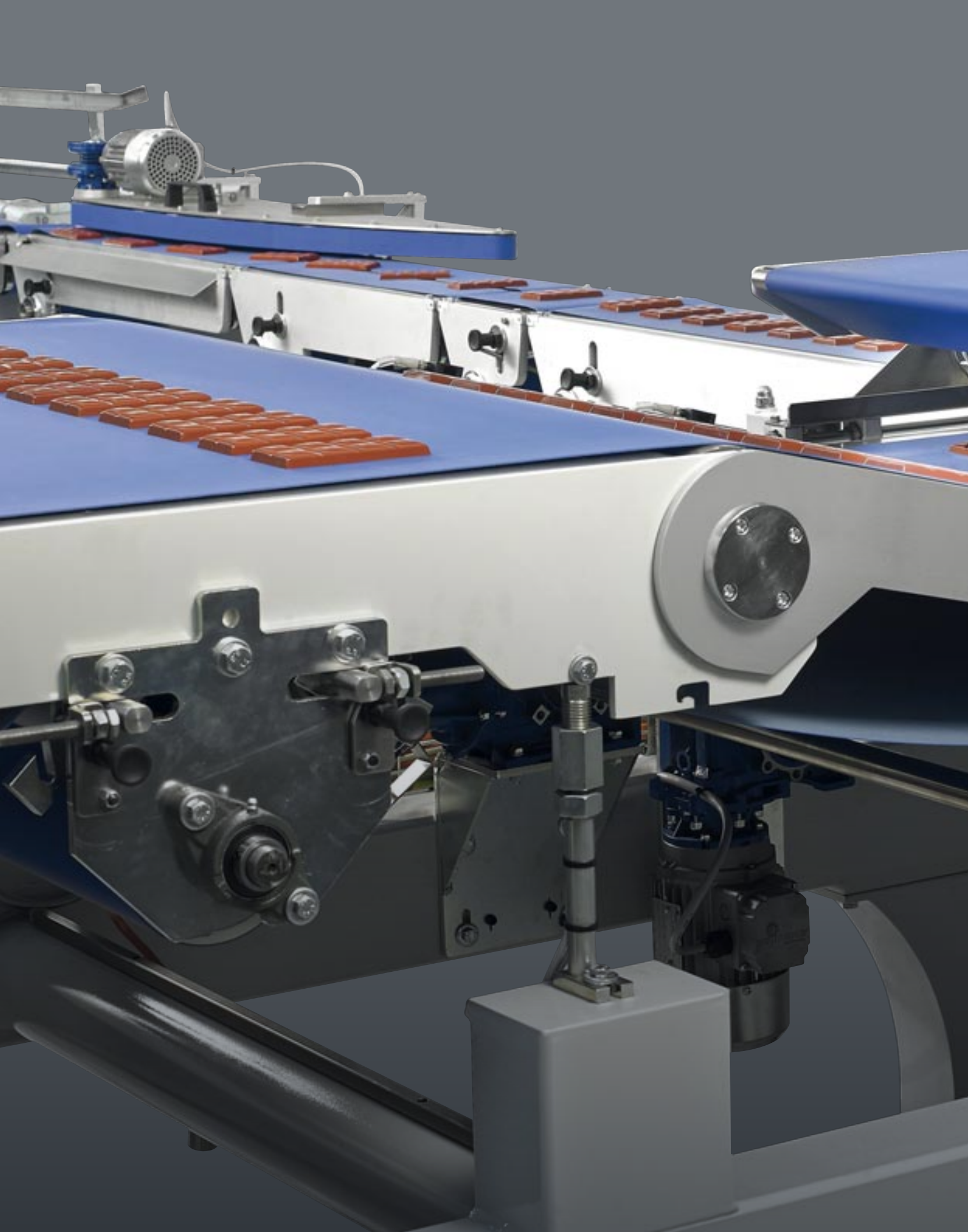

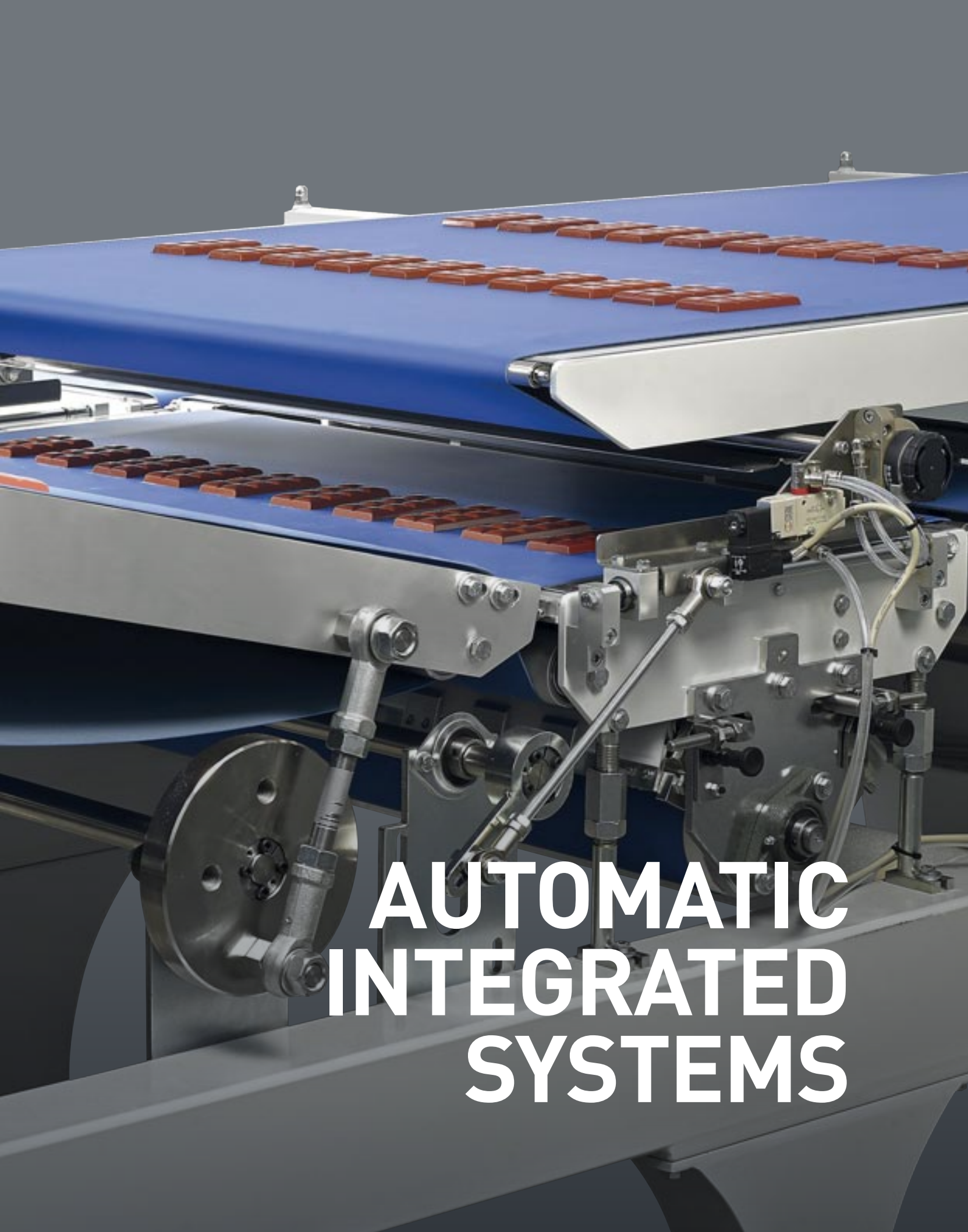

**AUTOMATIC
INTEGRATED
SYSTEMS**

PACKAGING LINES

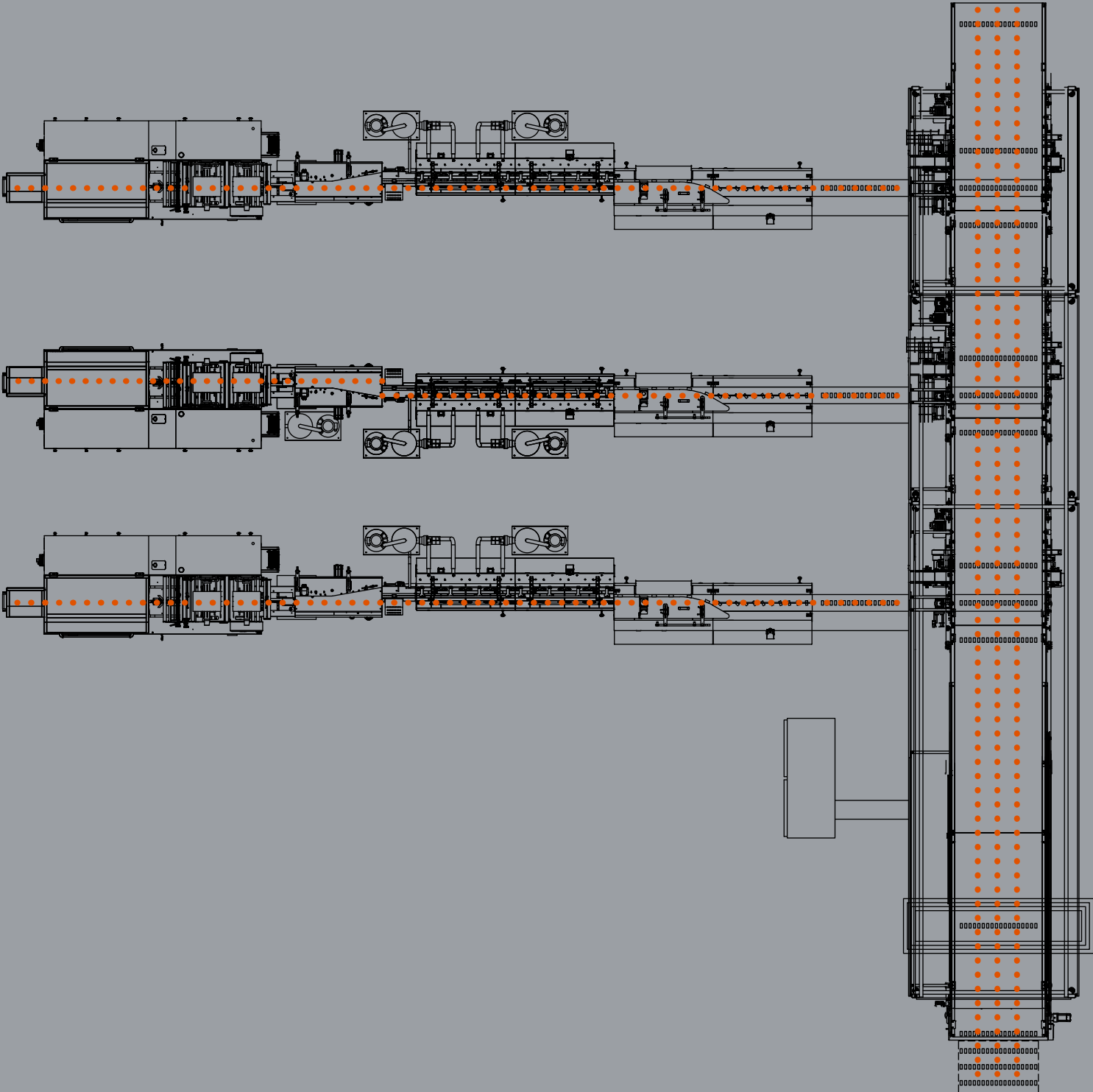



Row distribution system for products arriving in regular rows



Feeding and portioning system suitable for handling of wafers

PACKAGING LINES



Fully automatic system especially designed for bars arriving in aligned and regular rows



Row distribution system combined with electronic numerical loader for biscuits on edge





PACKAGING LINES



In-line feeding system with streamers suitable for small products arriving randomly



Packaging lines for products in trays

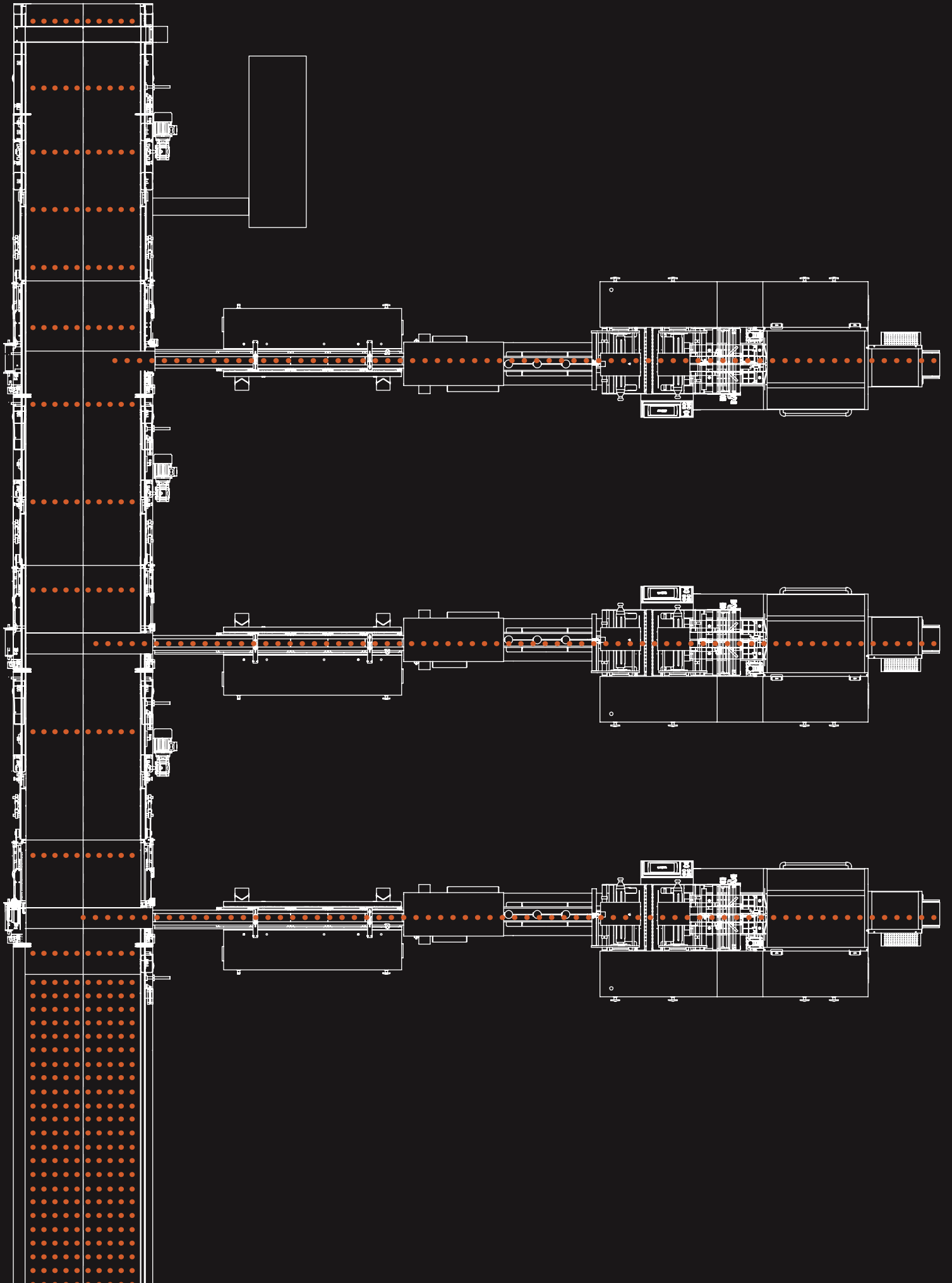

**IMAGINE
THE SOLUTION,
IMAGINE
THE POSSIBILITIES**



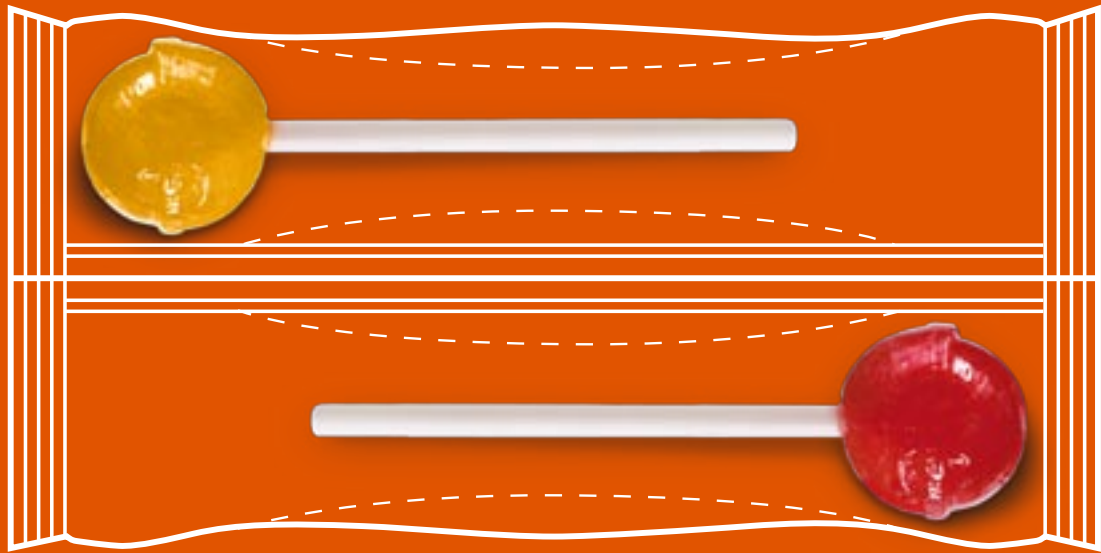

PACKAGING LINES

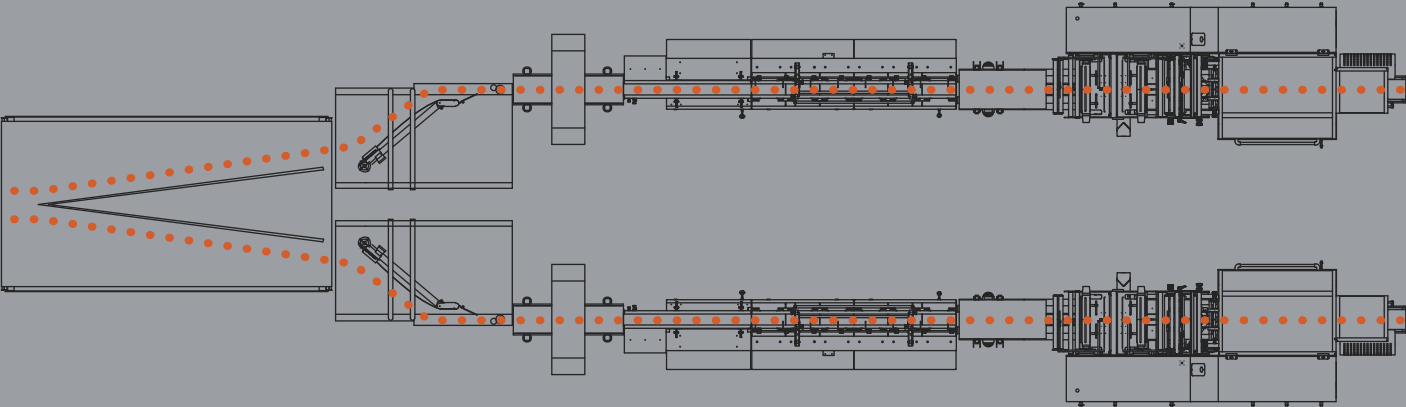
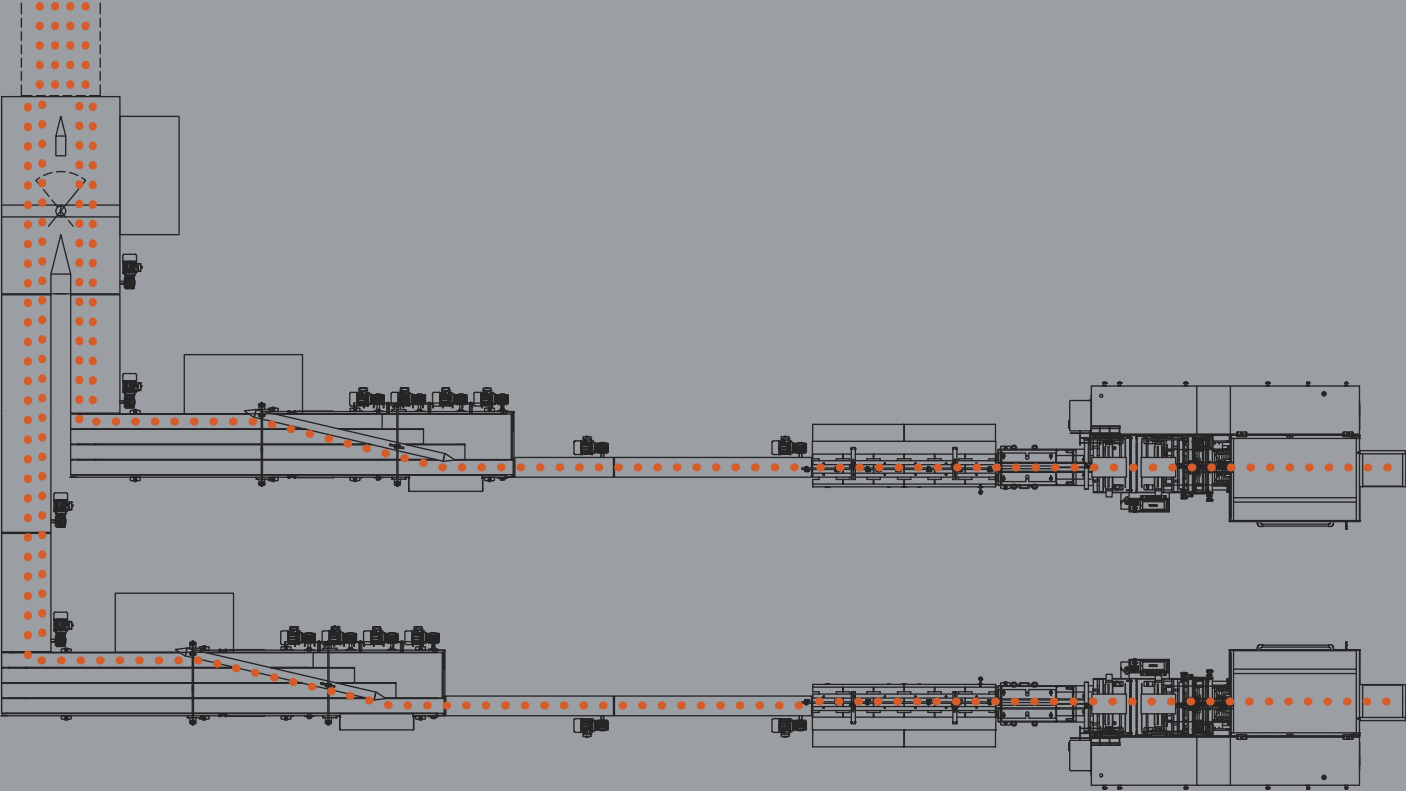



Row distribution system for biscuits



High-speed in-line feeders

PACKAGING LINES



Complete and fully automatic system for sandwich cookies



Automatic lines for multipacks and family packs



Special lines for pharmaceutical products

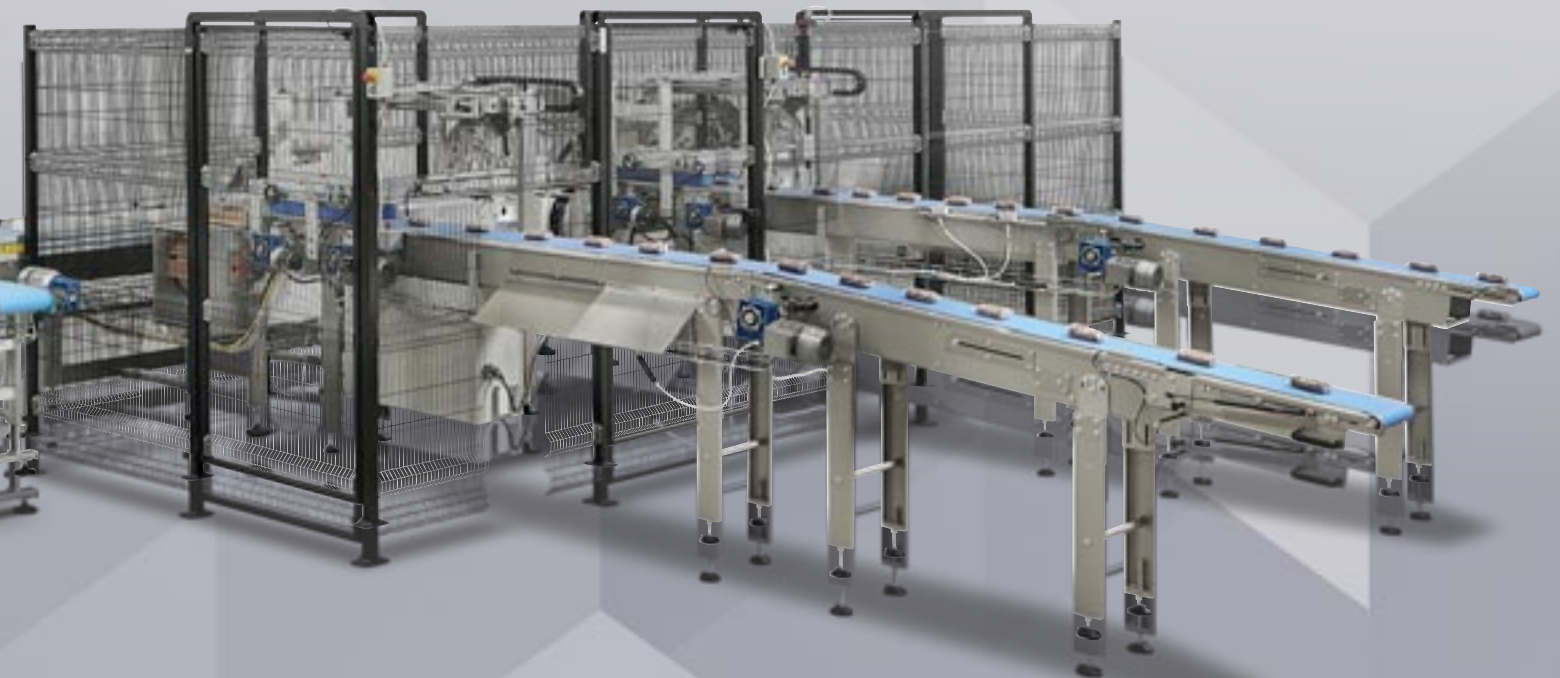

PACKAGING LINES

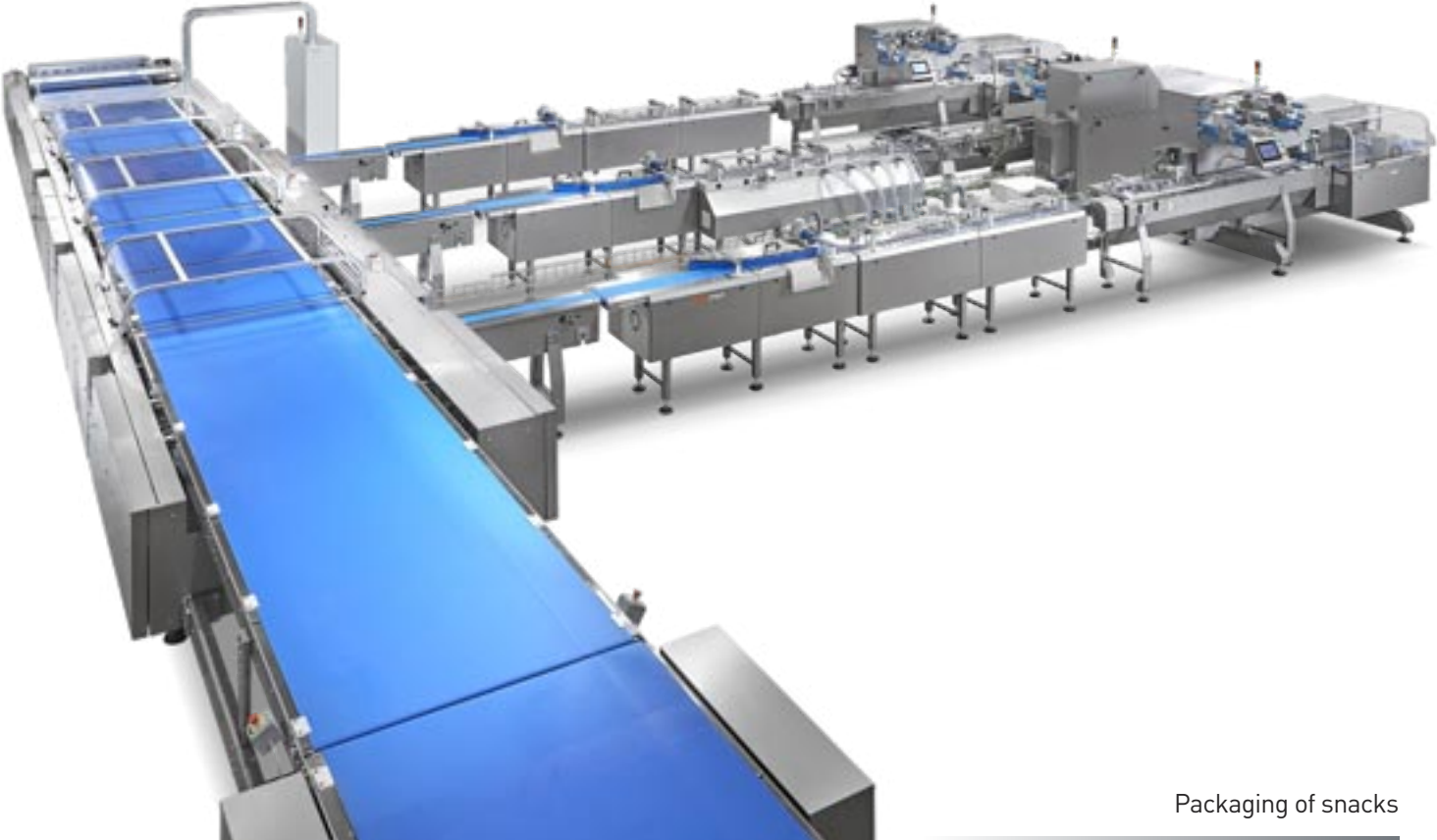

Packaging of snacks



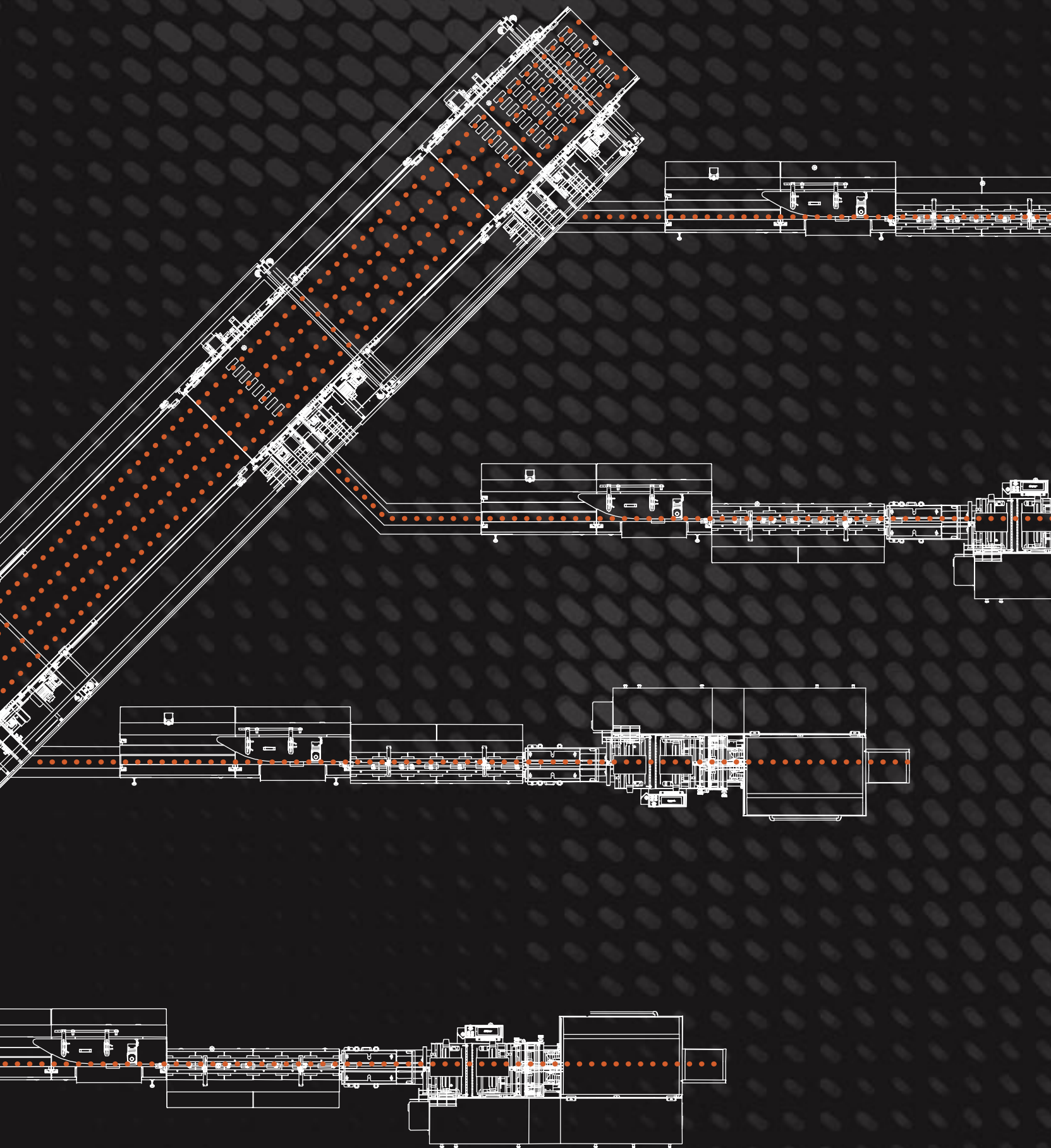

PACKAGING LINES



Robotic multipack system



Small and medium lines for wafers





**IMAGINE
THE SOLUTION,
IMAGINE
THE POSSIBILITIES**

**HARDWARE
PACKAGING MACHINES**



Vertical baggers



Robotic loading system

HARDWARE PACKAGING MACHINES

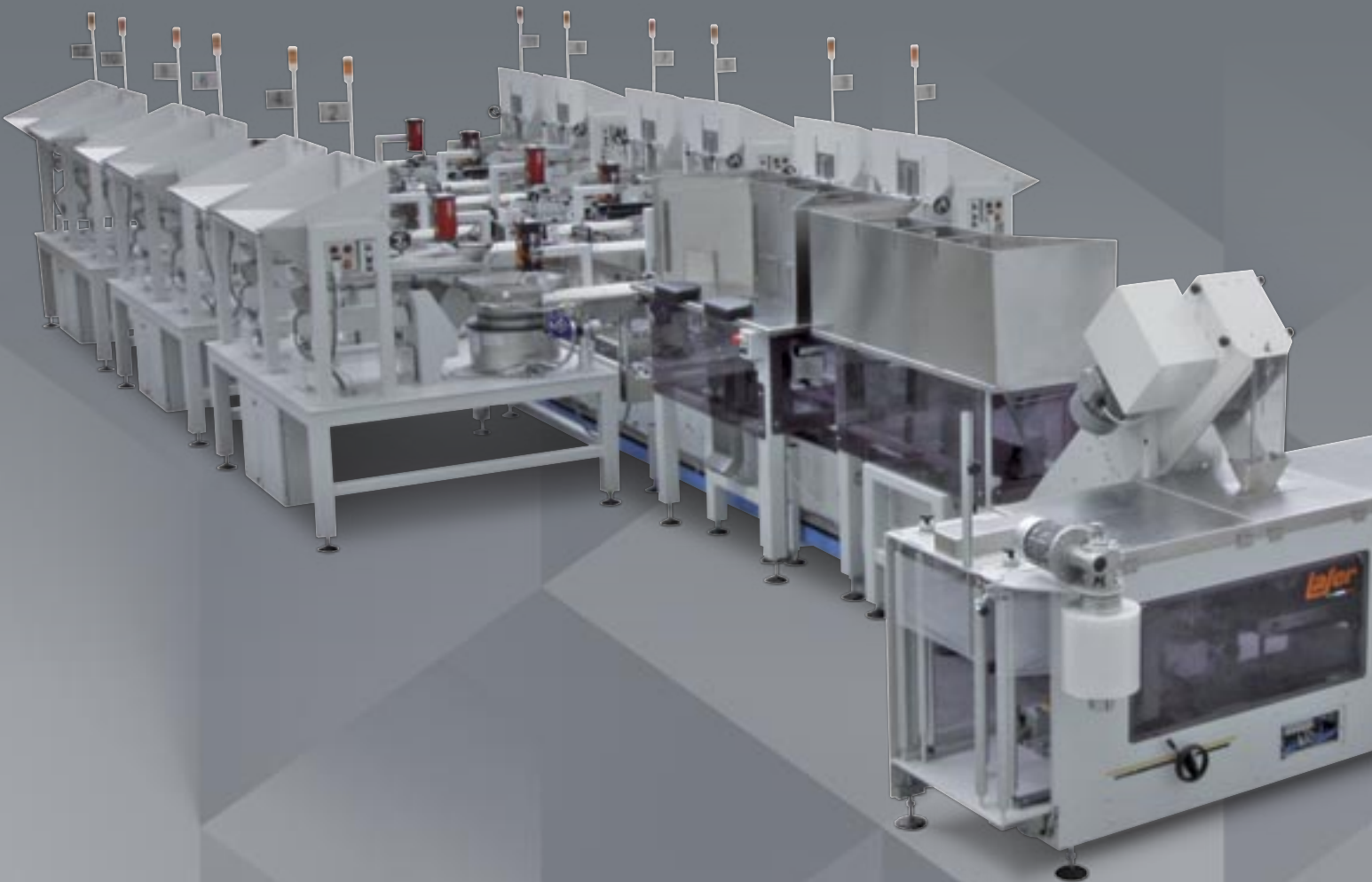
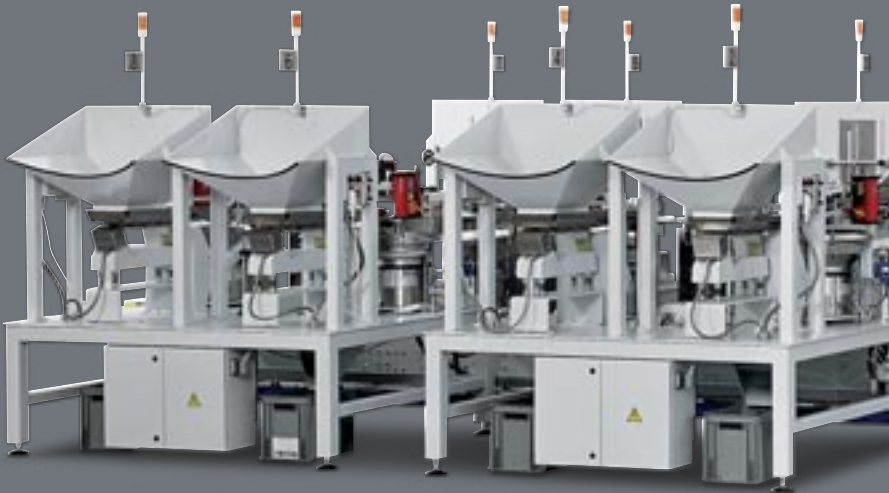





PACK IT YOUR WAY

www.laferpack.com

Lafer Packaging Srl

36015 Schio · Vicenza · Italy
Via Lago di Garda, 104

T +39 0445.694.170

info@laferpack.com
www.laferpack.com

